

構成内容 / Components				
No.	名称 / Part name	数量 / Pcs	材質 / Material	色・表面処理 / Color・Finish
1	パネル / Panel	2	アルミ板 A1100P / Aluminium A1100	シルバー・アルマイト, ブラック・塗装 / Silver・anodized, Black・painted
2	上カバー / Top cover	1	アルミ押出材 / Extruded aluminium A6063S-T5	シルバー, ブラック・アルマイト & クリア塗装 / Silver, Black・anodized with clear coating
3	下カバー / Bottom cover	1	アルミ押出材 / Extruded aluminium A6063S-T5	シルバー, ブラック・アルマイト & クリア塗装 / Silver, Black・anodized with clear coating
4	フランジ付フレーム Flanged frame	2	PC + ABS樹脂 (UL94V-0 主成分) PC + ABS Flame-resistant	塗装無: ブラック, グレー / Black, Gray・Unpainted 塗装付: ネイビー / Navy・Painted
5	取付ビス(六角穴付M2.5×8) Screw (Hexagonal M2.5×8)	8	ステンレス Stainless steel	無処理 Unfinished

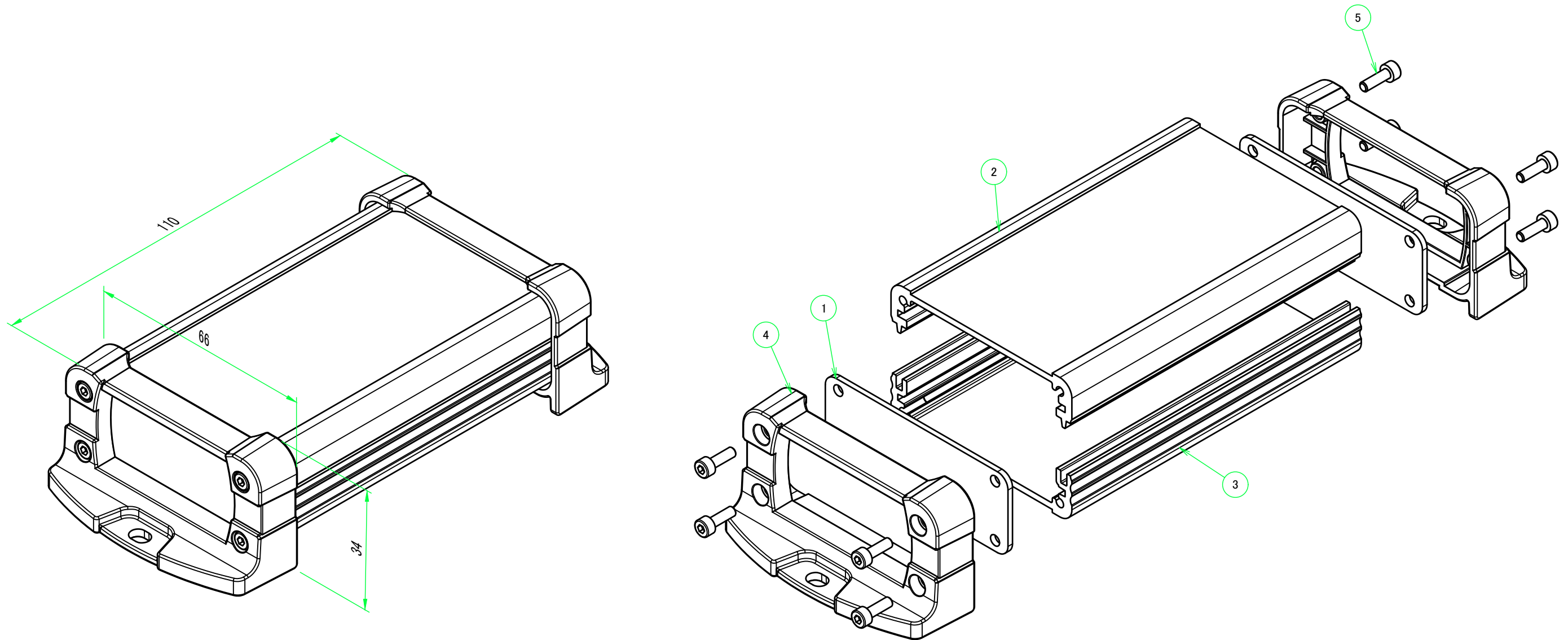

本図面および付帯する部品図の著作権は株式会社タカチ電機工業に帰属します。 / Copyright (C) TAKACHI ELECTRONICS ENCLOSURE CO., LTD. All Rights Reserved.

色仕様(型番末尾□□) / Color type (End of product number□□)		
記号 / Code	上下カバー / Cover	フレーム / Flanged frame
SB	シルバー / Silver	ブラック / Black
SG	シルバー / Silver	グレー / Gray
SN	シルバー / Silver	ネイビー / Navy
BB	ブラック / Black	ブラック / Black
BG	ブラック / Black	グレー / Gray
BN	ブラック / Black	ネイビー / Navy

株式会社タカチ電機工業 TAKACHI ELECTRONICS ENCLOSURE CO., LTD.			品名/Title フランジ足付アルミケース アルミパネルタイプ FLANGED ALUMINIUM PANEL CASE	尺度/Scale 1 : 1
承認/Approved	検図/Checked	製図/Created	型番/Product number EXPF7-3-11□□	
中根	大江	岡本	作成日/Date 2023/06/26	1 / 5

B-B (1:1.5)

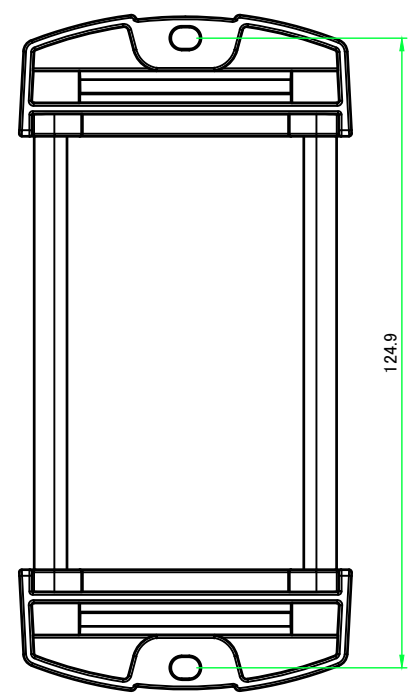
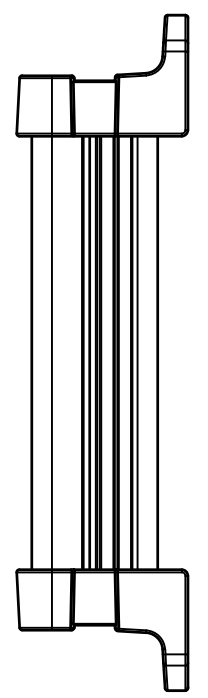
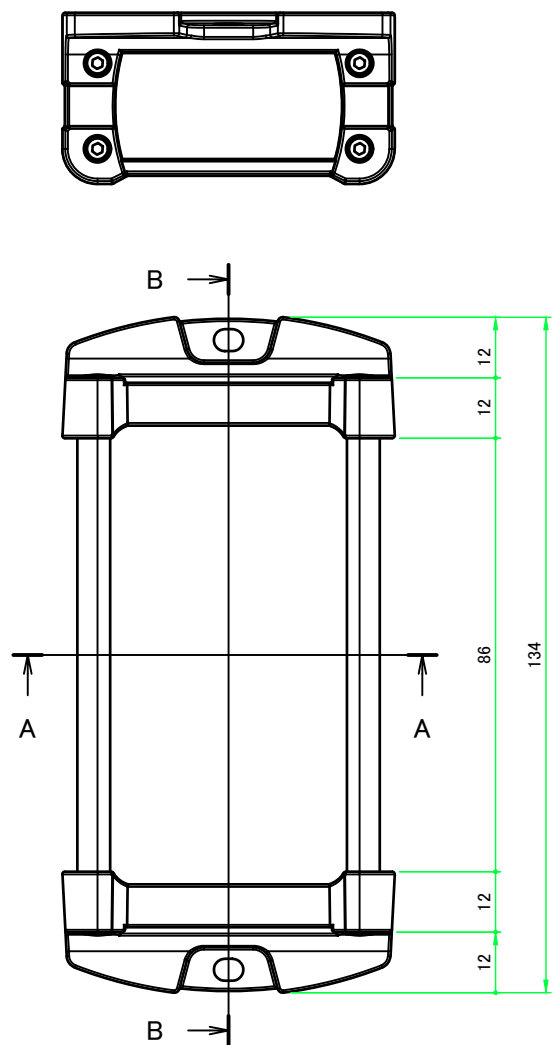
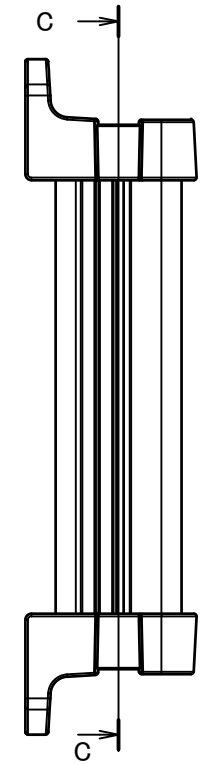
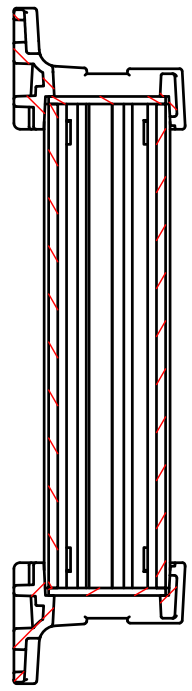

4-M2.5 六角穴付ボルト
4-M2.5 Countersunk hole

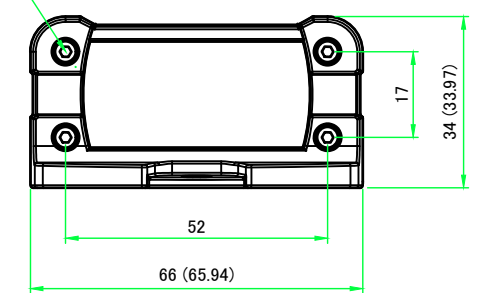

C-C (1:1.5)

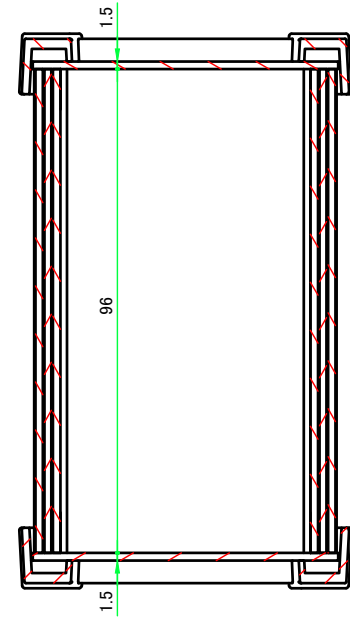

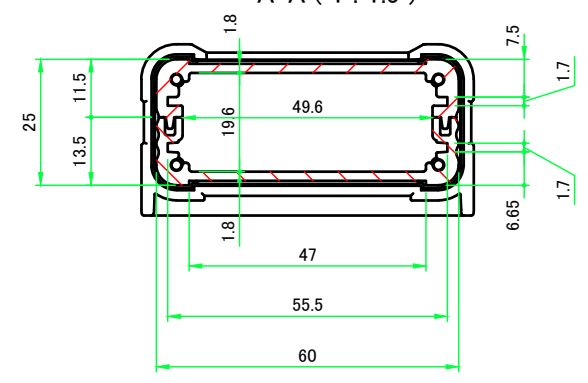

A-A (1:1.5)

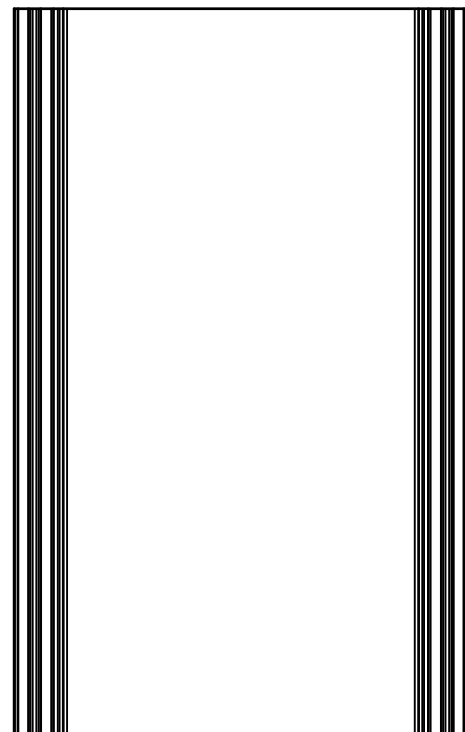
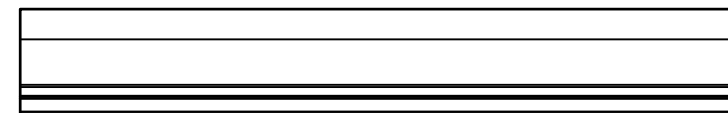
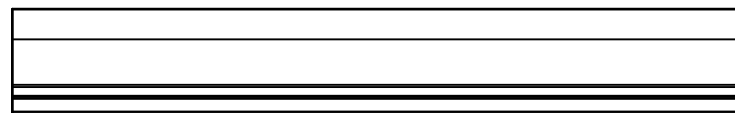
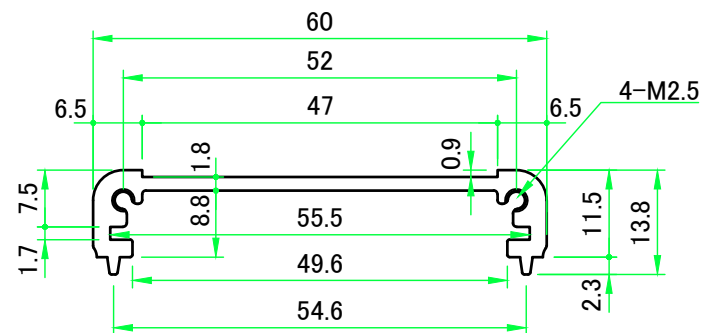
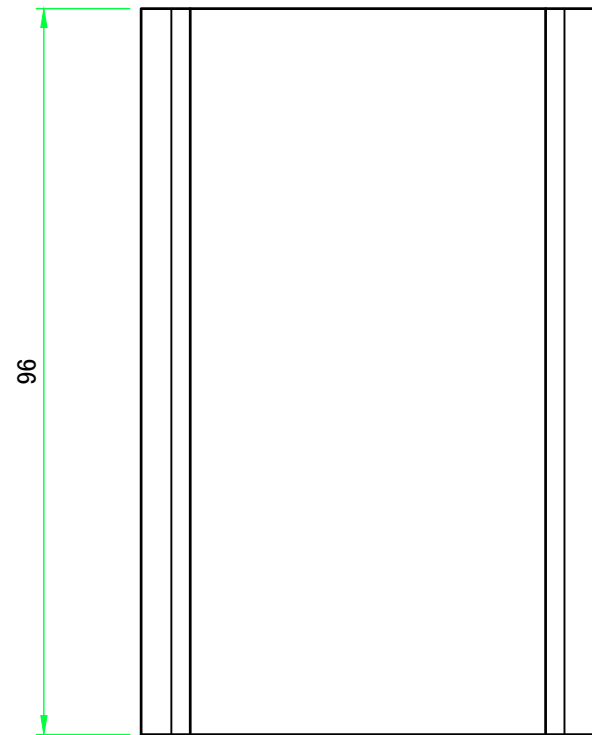

株式会社タカチ電機工業 TAKACHI ELECTRONICS ENCLOSURE CO., LTD.			品名/Title フランジ足付アルミケース アルミパネルタイプ FLANGED ALUMINIUM PANEL CASE	尺度/Scale 1:1.5
承認/Approved	検図/Checked	製図/Created	型番/Product number EXPF7-3-11□□	
中根	大江	岡本	作成日/Date 2019/03/05	2 / 5



 株式会社タカチ電機工業 TAKACHI ELECTRONICS ENCLOSURE CO., LTD.			品名/Title 上カバー TOP COVER	 尺度/Scale 1 : 1
承認/Approved	検図/Checked	製図/Created	型番/Product number W60-D96	
中根	大江	岡本	作成日/Date 2017/03/14	3 / 5

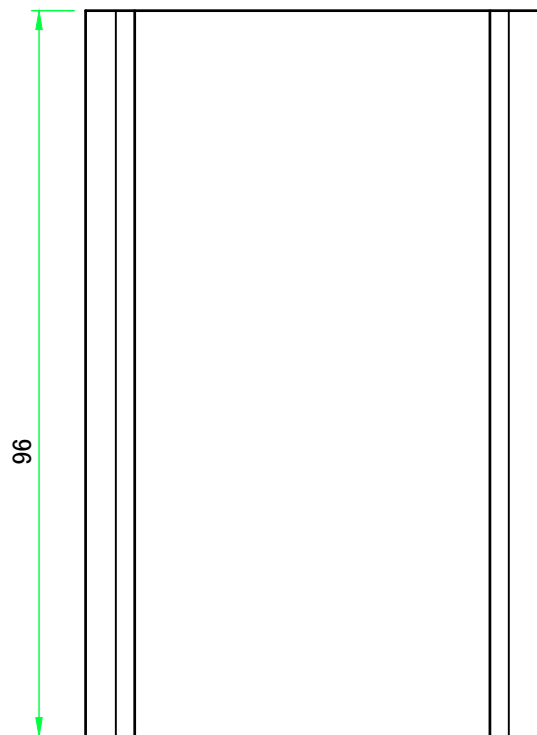
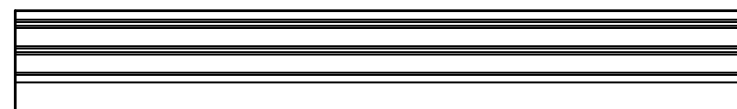
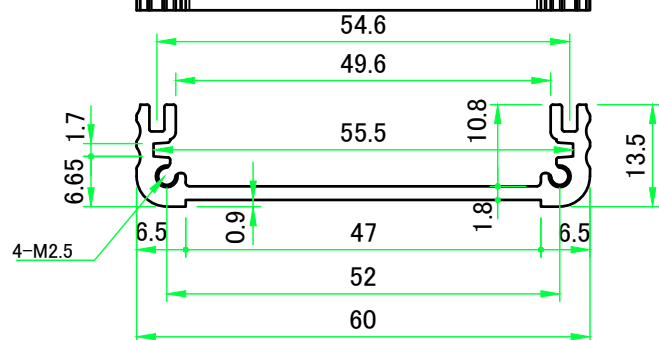
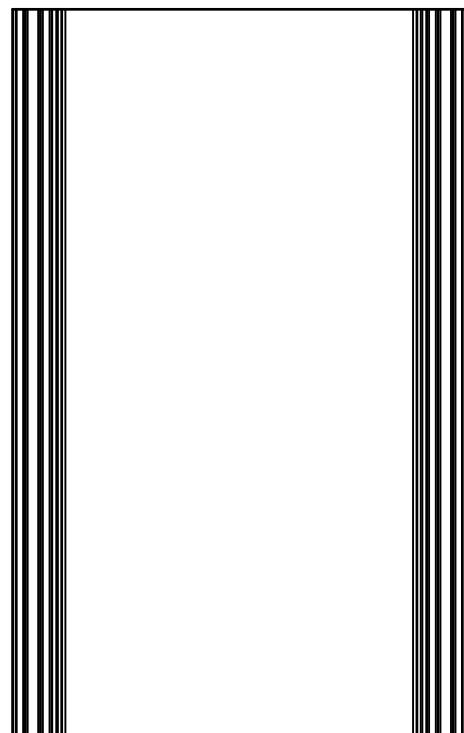
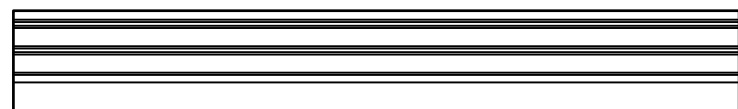

 株式会社タカチ電機工業 TAKACHI ELECTRONICS ENCLOSURE CO., LTD.			品名/Title 下カバー BOTTOM COVER	 尺度/Scale 1 : 1
承認/Approved 中根	検図/Checked 大江	製図/Created 岡本	型番/Product number W60-H25-D96	
			作成日/Date 2017/02/27	4 / 5

A-A (1:1)



C-C (1:1)

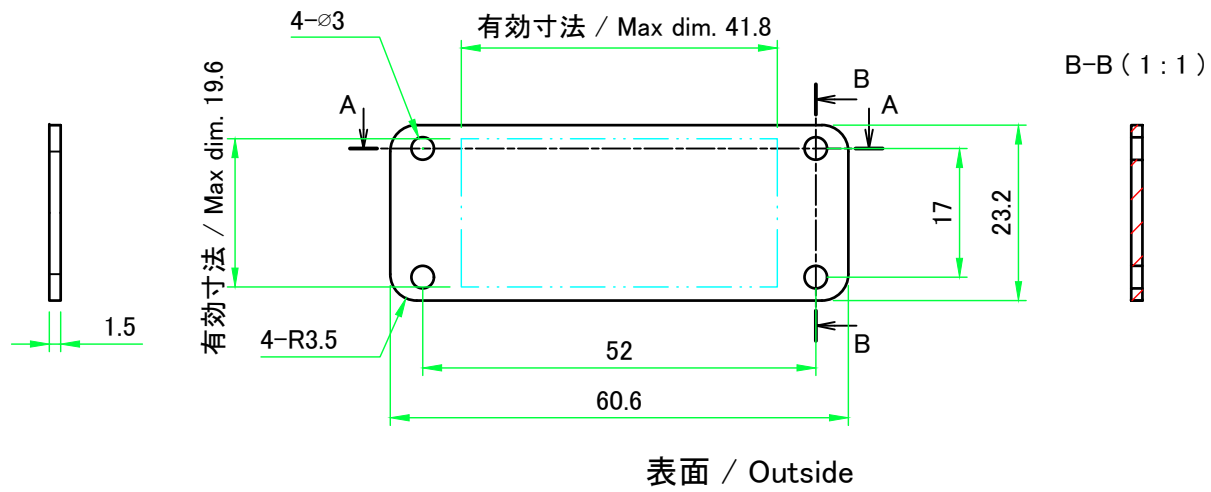

B-B (1:1)



保護シート側
Surface protective film side

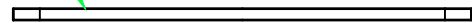

裏面 / Inside

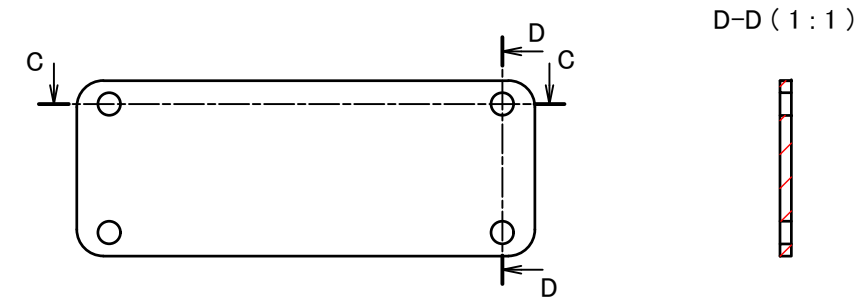

保護シート側
Surface protective film side

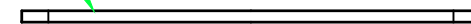

裏面 / Inside

株式会社タカチ電機工業 TAKACHI ELECTRONICS ENCLOSURE CO., LTD.			品名/Title パネル PANEL	尺度/Scale 1:1
承認/Approved	検図/Checked	製図/Created	型番/Product number W60 - H25	
中根	岡本	大江	作成日/Date 2023/06/26	5 / 5